

CR-2032

DIMENSIONS (MM)

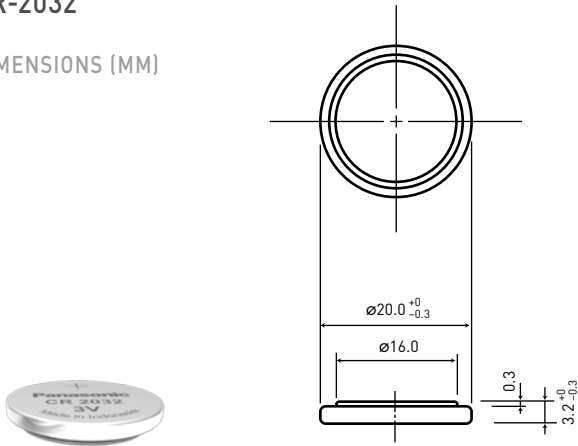

Model number	CR-2032
Nominal voltage (V)	3
Nominal capacity (mAh)	225
Diameter (mm)	20.0
Total height (mm)	3.2
Discharging temperature range (°C)	-30 to +60
Weight (g)	3.1

DISCHARGE TEMPERATURE CHARACTERISTICS

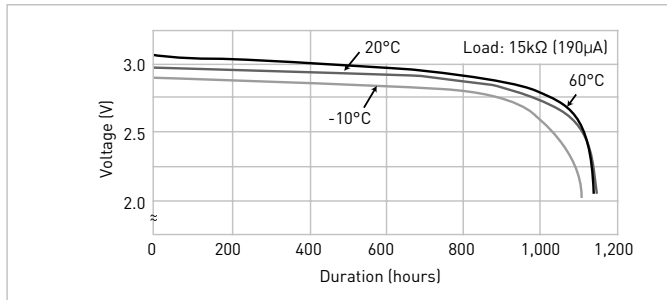

OPERATING VOLTAGE VS. DISCHARGE CURRENT*1

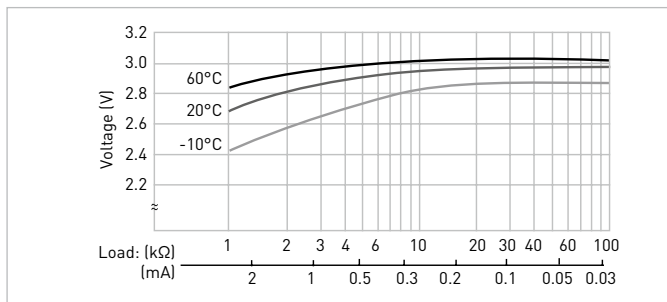

CAPACITY VS. LOAD RESISTANCE

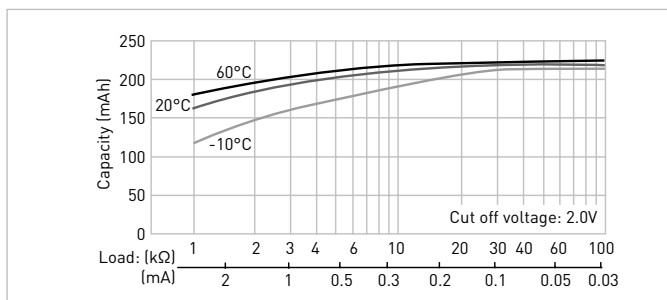

Lithium battery holders for CR-2032

These battery holders are designed for sure and easy loading/removal of Panasonic coin type Lithium batteries in/from equipment enabling the batteries to fully exploit their capabilities as the back-up power supply in C-MOS RAM memory and microcomputer memory. All of the battery holders are designed to prevent inverted insertion of

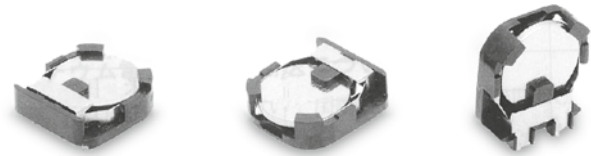

BCR20H4

BCR20H5

BCR20V4

BCR20H4 (3 terminals)

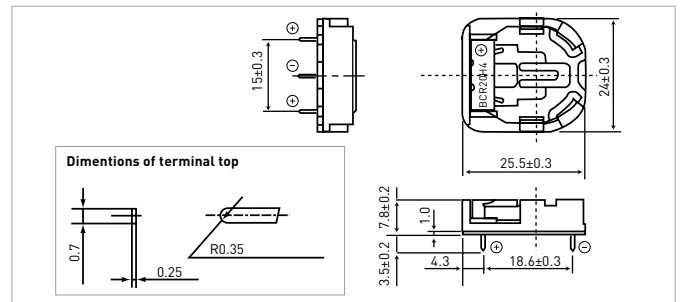

BCR20H5 (2 terminals)

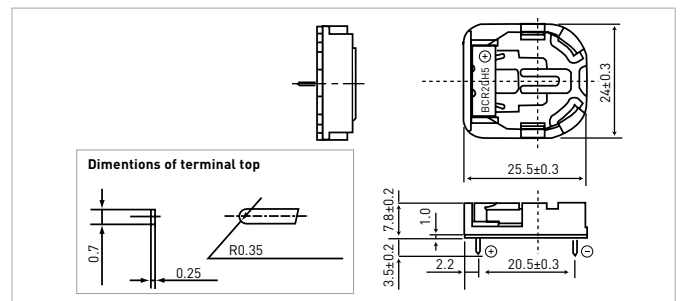

BCR20V4 (3 terminals)

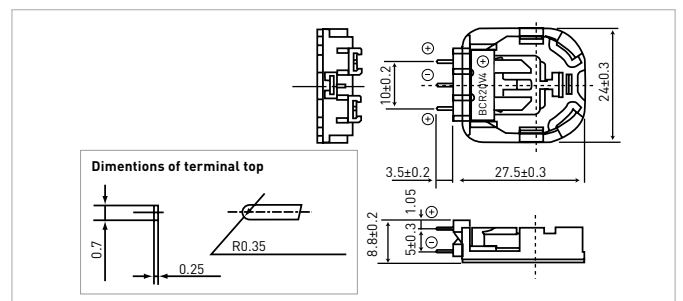

Precaution for washing battery holders

The battery holders can be adversely affected by some detergents use in the circuit board washing process and may result in cracks forming in the holder. Please test the holders in your washing process before use.